

Montaje para Soporte de Maleta Superior



Nota:

No apriete todos los tornillos hasta que no estén completamente alineadas todas las perforaciones con respecto a los puntos de sujeción.

Antes de realizar la instalación, verifique todo el manual e identifique que las partes y las piezas estén completas.

Herramientas:

Kit llaves hexágonas
Kit rache + copas



Kit Instalado

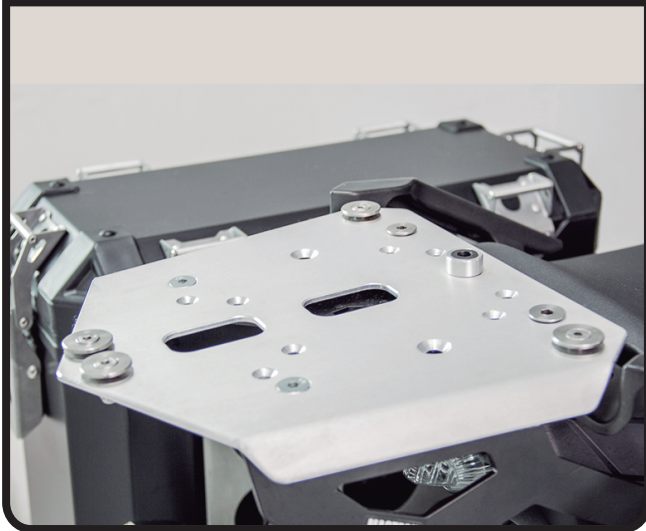







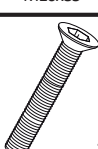
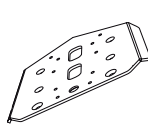

Instalación

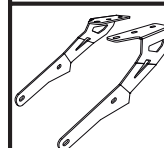

Imagen 1

El Kit Contiene:

<p>Tornillo Avellanado M10x85</p>  <p>T1</p> <p>Cantidad: 2</p>	<p>Platina Top Case</p>  <p>Cantidad: 1</p>	<p>Arandela plana M8</p>  <p>AA1</p> <p>Cantidad: 4</p>	<p>Buje Aluminio DEXT 28</p>  <p>B1</p> <p>Cantidad: 2</p>
<p>Platina Equis Top Case</p>  <p>Cantidad: 1</p>	<p>Platina Soporte Lateral</p>  <p>Cantidad: 2</p>	<p>Tuerca Seg. M8</p>  <p>TC1</p> <p>Cantidad: 4</p>	<p>Buje Aluminio DEXT 19 largo</p>  <p>B2</p> <p>Cantidad: 2</p>
<p>Tomillo Avellanado M8x20</p>  <p>T2</p> <p>Cantidad: 4</p>	<p>Buje Aluminio DEXT 19 corto</p>  <p>B3</p> <p>Cantidad: 2</p>		

1- Retire los tornillos originales que se ubican en la Imagen 1, coloque las platinas de soporte lateral con los bujes B2 y B3, ajuste con los mismos tornillos retirados.

2- Una vez colocados los soportes laterales instale la platina equis y la platina top case como se representa en el Esquema 1.

3- Verifique que todas las piezas y tornillos se encuentran en la posición correcta y bien ajustados antes de su uso.

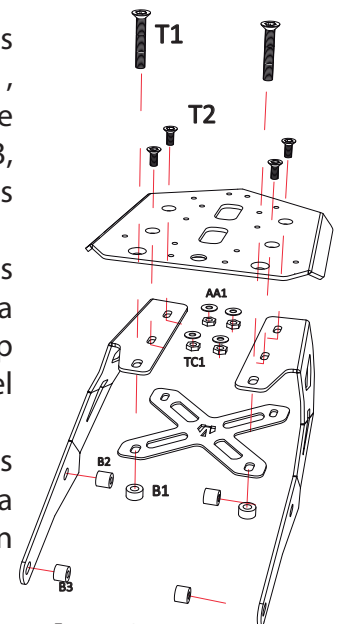

Esquema 1

Assembly Instructions for Top Case



Note:

Do not tighten the screws until they are completely aligned with the holes over the attachment points.

Before the installation, please verify through the manual that all pieces and parts are complete.

Tools Required:

Hex Allen Wrench Set
Ratchet and Socket Set



Assembled Kit

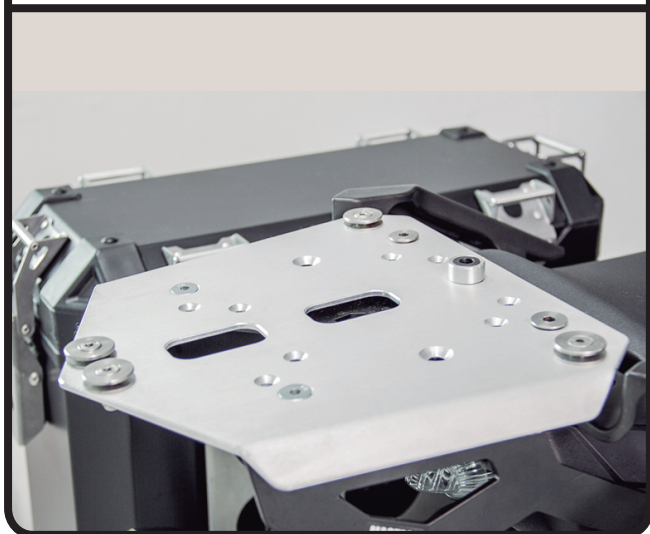

Installation



Image 1

Parts Included

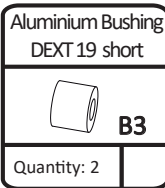
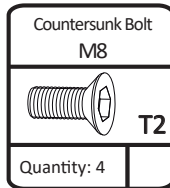
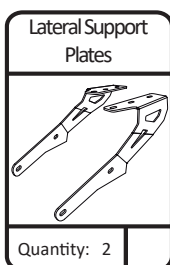
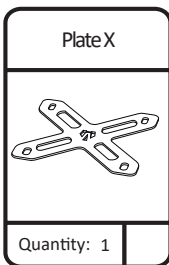
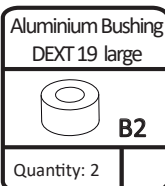
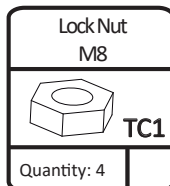
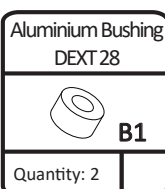
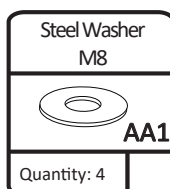
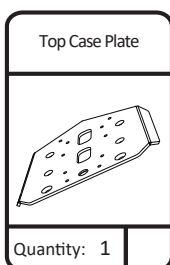
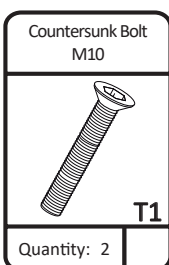

1- Remove the original screws that are located in the Image 1 , place the lateral support plates with B2 and B3 bushings, fit with the same screws removed .

2- Once placed lateral support plates, install the plate X and the top case plate as shown in Diagram 1 .

3- Check that all parts and screws are in the correct position and tight before use.

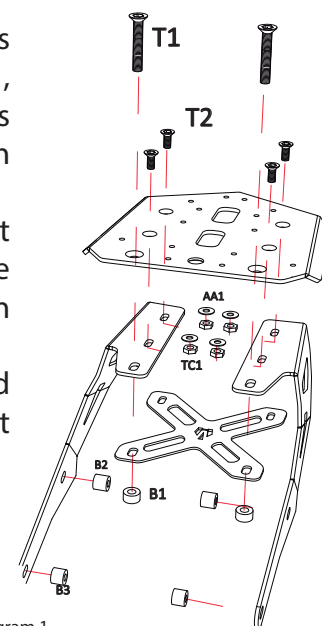

Diagram 1