



MASTECH

Kawasaki Versys 250 X 17/UP

Montaje para protector de faro

**Nota:**

No apriete todos los tornillos hasta que no estén completamente alineadas todas las perforaciones con respecto a los puntos de sujeción.

Antes de realizar la instalación, verifique todo el manual e identifique que las partes y las piezas estén completas.

Herramientas:

Kit llaves hexágonas

Kit llaves boca fija



Kit Instalado





Instalación

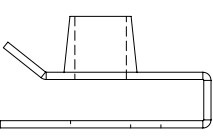

- 1- Instale las chapetas en la parte inferior de la farola.
- 2- Instale la platina inferior y asegure el protector de faro en la parte inferior como se muestra en el esquema.
- 3- Instale el faro en la parte superior con la tornillería original donde muestra la imagen.

El Kit Contiene:

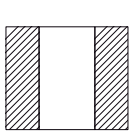
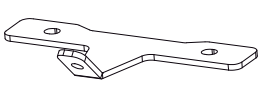
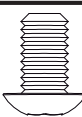
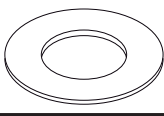
<p>Chapeta M6</p>  <p>Cantidad: 2</p>	<p>Tornillo bristol socket M6x30</p>  <p>Cantidad: 2</p>	<p>Buje aluminio Dext 5/8" Dint 8.2 Alt 10</p>  <p>Cantidad: 2</p>
<p>Platina sujecion inferior</p>  <p>Cantidad: 1</p>	<p>Tornillo button M6x10</p>  <p>Cantidad: 1</p>	<p>Arandela M6</p>  <p>Cantidad: 2</p>

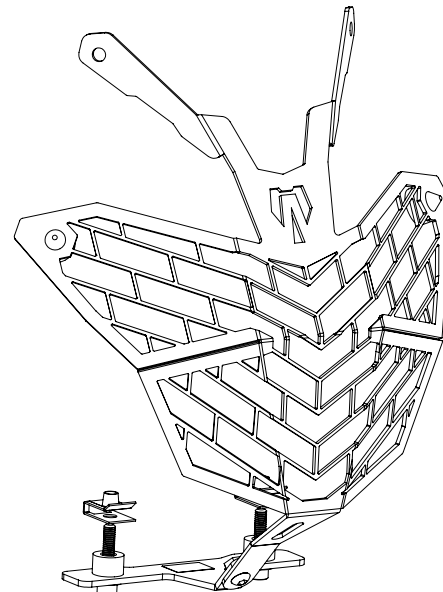

Al terminar la instalación de las partes, verifique que estén alineadas y que toda la tornillería esté debidamente apretada; reajuste todos los tornillos.



MASTECH

Kawasaki Versys 250 X 17/UP

Assembly Instructions for headlight guard

**Note :**

Do not tighten the screws until they are completely aligned with the holes.
Before the installation, please verify through the manual that all pieces and parts are complete.

Tools Required:

Hex Allen Wrench Set
Combination Wrench Set



Assembled Kit







Installation

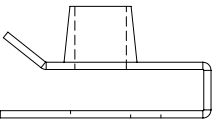

- 1- Install the clamps below the headlight.
- 2- Install the lower support to assembly the headlight guard in the lower hole as is shown in the image.
- 3- Install the upper headlight guard holes in with the bolts and holes shown in the upper image.

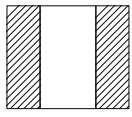
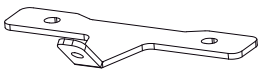
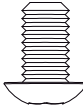
Parts Included:

<p>thread clamp</p>  <p>Quantity: 2</p>	<p>Socket bolt M6x30</p>  <p>Quantity: 2</p>	<p>Aluminium bushing Dext 5/8" Dint 8.2</p>  <p>Quantity: 2</p>
<p>Lower support</p>  <p>Quantity: 1</p>	<p>Button bolt M6x10</p>  <p>Quantity: 1</p>	<p>Washer M6</p>  <p>Quantity: 2</p>

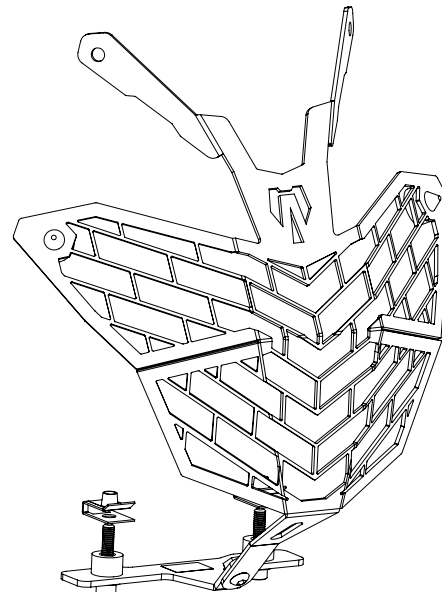

After the installation of the parts, please check that they are aligned and that all the hardware is properly tightened