

**Montaje Protector de Faro**

**Nota:**

No apriete todos los tornillos hasta que no estén completamente alineadas todas las perforaciones con respecto a los puntos de sujeción.

Antes de realizar la instalación, verifique todo el manual e identifique que las partes y las piezas estén completas.

**Herramientas:**

Kit llaves hexágonas

Kit llaves Boca Fija



# Kit Instalado





# Instalación

1. Retirar los Tornillos del Punto 1, utilice Llave boca fija 10mm y llaver torx.
2. Retirar los Tornillos del Punto 2, utilice Llave llaver torx.
3. Retire direccional y monte cada platina entre la moto y la direccional
4. Utilice buje BUJ1 y Tornillo TORN1 para instalar el punto 2
5. Utilice la tornillería de la moto para instalar el punto 1

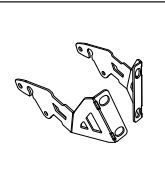

# El Kit Contiene

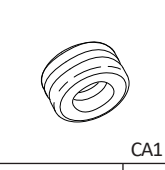
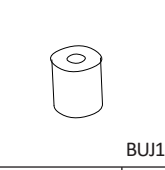
Platina Frontal Negra con Pines  Cantidad: 1	Platinas Laterales Inox Derecha - Izquierda  Cantidad: 1 c/u	BUTTON M5 X 30 INOX  TORN1 Cantidad: 2
Cauchos PVC M8  CA1 Cantidad: 4	Buje aluminio DEXT 15.9 - D INT 6.5 ALT 15.5  BUJ1 Cantidad: 2	

# Esquema:

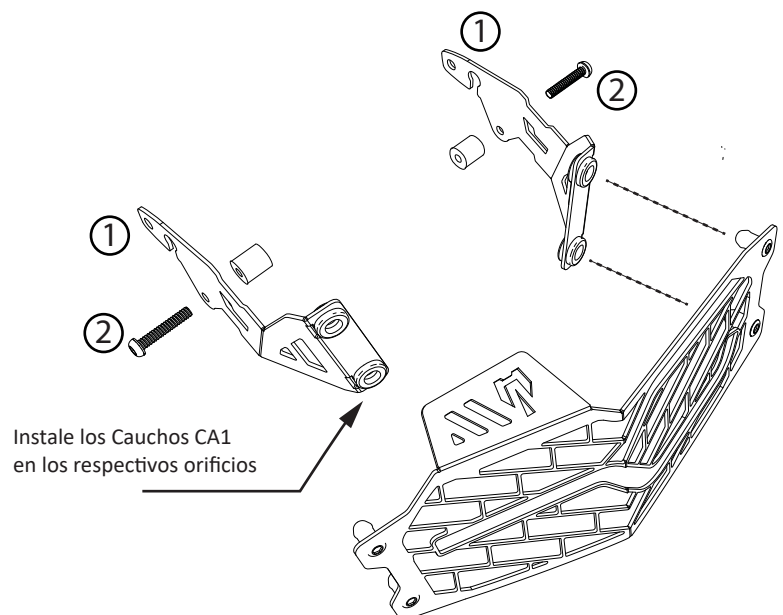

Al terminar la instalación de las partes, verifique que estén alineadas y que toda la tornillería esté debidamente apretada; reajuste todos los tornillos.

Assembly Instructions Headlighth Protector



**Note :**

Do not tighten the screws until they are completely aligned with the holes.  
Before the installation, please verify through the manual that all pieces and parts are complete.

**Tools Required:**

Hex Allen Wrench Set  
Combination Wrench Set



## Assembled Kit







## Installation

1. Remove the screws from point 1, use 10mm fixed-end wrench and torx key.
2. Remove the Screws from Point 2, use Torx Key
3. Remove the lighth signal and mount the suppor sheet between the motorcycle and the lighth signal
4. Use aluminum spacer BUJ1 and screw TORN1 to install point 2
5. Use the motorcycle Screws to install point 1

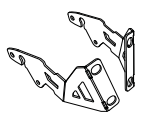

## instalation Kit

<p>Headlighth sheet protector</p>  <p>Qtty: 1</p>	<p>Headlighth sheet lateral support</p>  <p>Qtty: 1 c/u</p>	<p>BUTTON M5 X 30 INOX</p>  <p>TORN1</p> <p>Qtty: 2</p>
<p>Rubber Grommet M8</p>  <p>CA1</p> <p>Qtty: 4</p>	<p>Aluminum Spacer D EXT 15.9 - D INT 6.5 ALT 15.5</p>  <p>BUJ1</p> <p>Qtty: 2</p>	

## Diagram

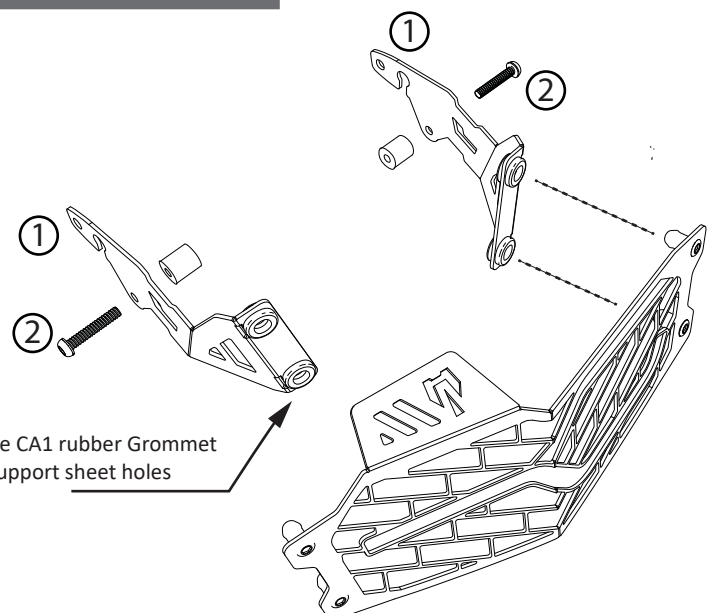

*After the installation of the parts, please check that they are aligned and that all the hardware is properly tightened*