

Montaje para base maleta textil



Nota:

No apriete todos los tornillos hasta que no estén completamente alineadas todas las perforaciones con respecto a los puntos de sujeción.

Antes de realizar la instalación, verifique todo el manual e identifique que las partes y las piezas estén completas.

Herramientas:

Kit llaves hexágonas

Kit llaves boca fija



Kit Instalado













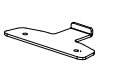

Instalación



- 1- Desmonte los 4 tornillos superiores de la parrilla original de la moto.
- 2- Instale los 4 bujes MASTECH en la parte superior de la parrilla original de la moto.
- 3- Ensamble la tornillería y bujes como lo muestra el esquema.

El Kit Contiene:

<p>Arandela plana M6 Inox</p>  <p>Ara1</p> <p>Cantidad: 2</p>	<p>Buje moneda inox</p>  <p>Buj1</p> <p>Cantidad: 2</p>	<p>Buje aluminio D EXT 15.5 (5/8") - D INT 8.5 - ALT 18</p>  <p>Buj2</p> <p>Cantidad: 2</p>	<p>Buje aluminio D EXT 15.5 (5/8") - D INT 8.5 - ALT 17</p>  <p>Buj3</p> <p>Cantidad: 2</p>	<p>Buje aluminio D EXT 19.05 (3/4") - D INT 8.5 - ALT 20</p>  <p>buj4</p> <p>Cantidad: 2</p>	<p>Platina inox enganche trasero.</p>  <p>Pla1</p> <p>Cantidad: 1</p>	<p>Platina inox soporte lateral (R)</p>  <p>Pla2</p> <p>Cantidad: 1</p>
<p>Platina inox soporte lateral (L)</p>  <p>Pla3</p> <p>Cantidad: 1</p>	<p>Tornillo bristol socket M8 x 70.</p>  <p>T1</p> <p>Cantidad: 2</p>	<p>Tornillo bristol socket M8 x 60.</p>  <p>T2</p> <p>Cantidad: 2</p>	<p>Tornillo bristol avellanado M6 x 30.</p>  <p>T3</p> <p>Cantidad: 2</p>	<p>Tornillo bristol avellanado M8 x 60</p>  <p>T4</p> <p>Cantidad: 2</p>	<p>Tuerca seg. 6 inox.</p>  <p>T5</p> <p>Cantidad: 2</p>	

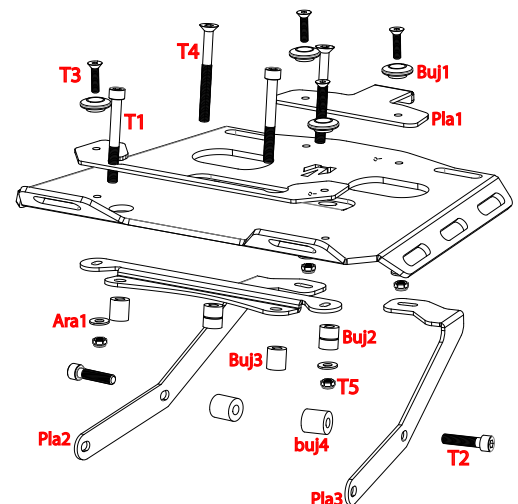

Al terminar la instalación de las partes, verifique que estén alineadas y que toda la tornillería esté debidamente apretada; reajuste todos los tornillos.



Assembly Instructions for rear rack

**Note :**

Do not tighten the screws until they are completely aligned with the holes.
Before the installation, please verify through the manual that all pieces and parts are complete.

Tools Required:

Hex Allen Wrench Set
Combination Wrench Set



Assembled Kit



Installation



- 1- Remove the top 4 screws of the original grill of the motorcycle.
- 2- Install the 4 MASTECH bushings on the top of the grill Original motorcycle.
- 3- Assemble the hardware and bushings as shown in the diagram.

Parts Included:

Flat washer M6 inox Ara1 Quantity: 2	Bushing inox Buj1 Quantity: 2	Bushing aluminium D EXT 15.5 (SHF) - D INTES - APT 18 Buj2 Quantity: 2	Bushing aluminium D EXT 15.5 (SHF) - D INTES - APT 17 Buj3 Quantity: 2	Bushing aluminium D EXT 19.05 (SHF) - D INTES - APT 20 buj4 Quantity: 2	Platen hitch rear inox Pla1 Quantity: 1	Side plate hitch (R) Pla2 Quantity: 1
Side plate hitch (L) Pla3 Quantity: 1	Allen screw socket M8 x 70. T1 Quantity: 2	Allen screw socket M8 x 60. T2 Quantity: 2	Allen screw M6 x 30 T3 Quantity: 2	Allen screw M8 x 60. T4 Quantity: 2	Safety nut M6 inox. T5 Quantity: 2	

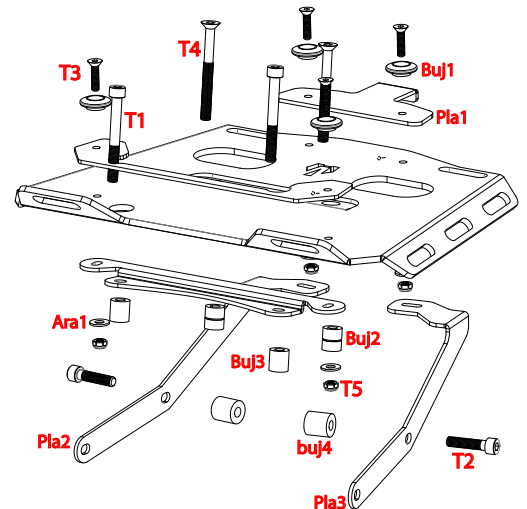

After the installation of the parts, please check that they are aligned and that all the hardware is properly tightened