

Montaje para Protector de Carenaje



Nota:

No apriete todos los tornillos hasta que no estén completamente alineadas todas las perforaciones con respecto a los puntos de sujeción.

Antes de realizar la instalación, verifique todo el manual e identifique que las partes y las piezas estén completas.

Herramientas:

Kit llaves hexágonas Kit rache + copas
 Kit llaves boca fija



Kit Instalado

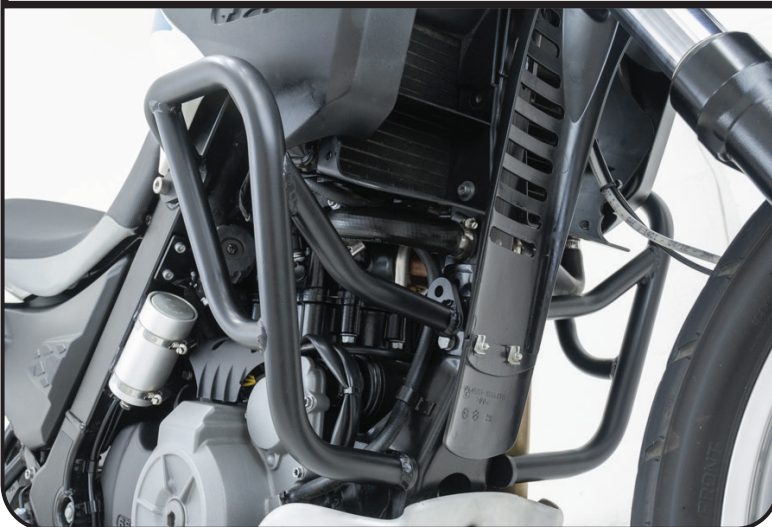

Instalación

Comience la instalación por la barra derecha.

1- Retire el tornillo señalado en la *Imagen 1*, en ambos lados de la moto.









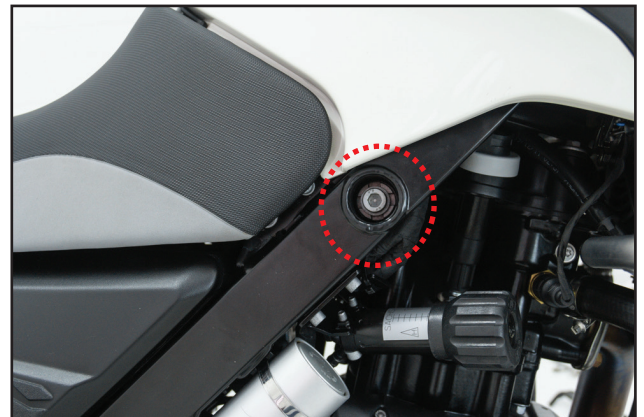
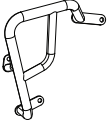
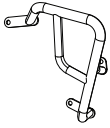
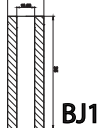
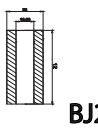

Imagen 1

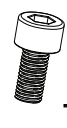
El Kit Contiene:

Barra Izquierda  Cantidad: 1	Barra Derecha  Cantidad: 1	Buje aluminio para chasis derecho  BJ1 Cantidad: 1	Buje aluminio para chasis izquierdo  BJ2 Cantidad: 1	Tornillo Hexagonal M10 x 120 Galv.  TC1 Cantidad: 1	Tornillo Socket M8 X 75 galv  TC2 Cantidad: 1
Tornillo Socket M10 X 90 galv  TC3 Cantidad: 1	Tornillo Socket M10X 70 galv  TC4 Cantidad: 1	Tuerca de Seg. M8 Galv.  TC5 Cantidad: 1	Tuerca de seg. M10 Galv.  TC6 Cantidad: 1	Arandela plana M8 galv.  TC7 Cantidad: 2	Arandela plana M10 galv.  TC8 Cantidad: 2

2- Retire los tornillos señalados en la *Imagen 2*.



Imagen 2

3 - Instale la parte superior de la barra derecha, con la tornillería BJ1, TC3 y TC8 en el orden que indica la *Imagen 3* y el esquema.

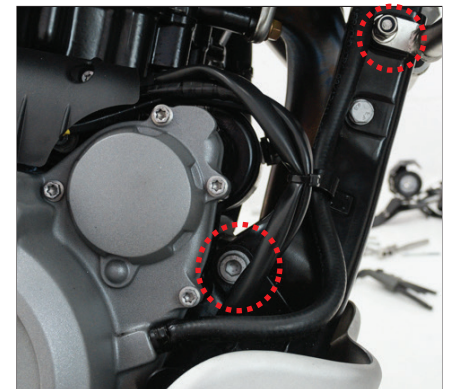

Imagen 3

5 - Instale la tornillería TC1 en el orden que indica la *Imagen 5* y el esquema.

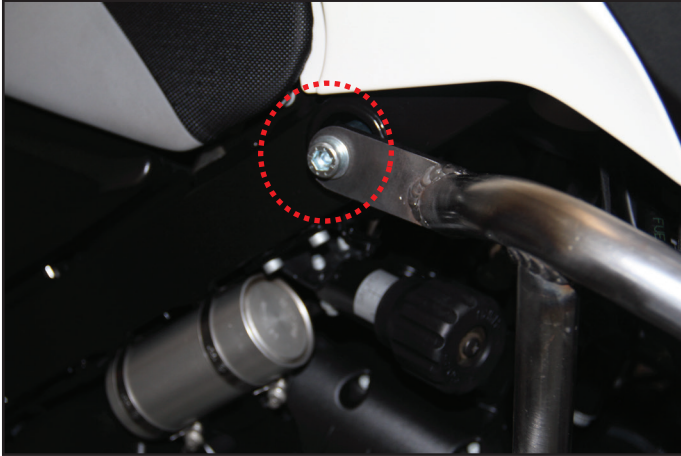
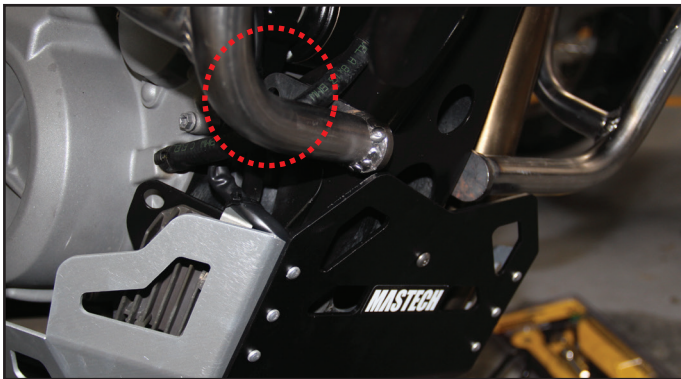

Image 5

4 - Instale la tornillería TC2 y TC7 en el orden que indica la *Imagen 4* y el esquema.



Imagen 4

6- Para iniciar la instalación de la barra izquierda repita el paso 3 utilizando la tornillería BUJ2, TC4 Y TC8 en el orden que indica el esquema.

7- Cuando la barra izquierda este totalmente ensamblada, asegure los tornillos pasantes con las tuercas de seguridad TC5 y TC6 en el orden que lo indica el esquema.

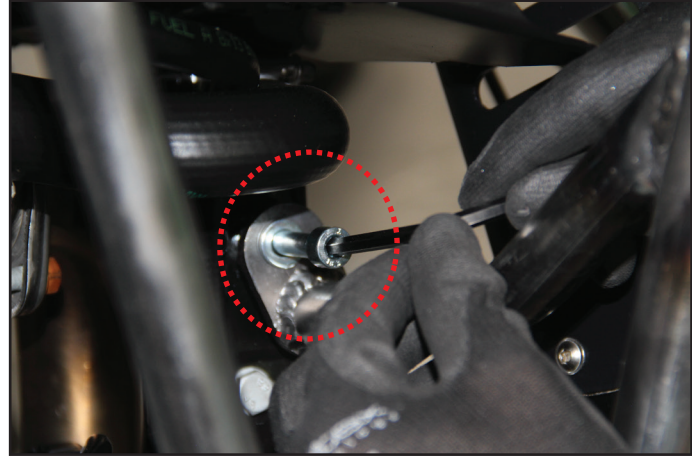
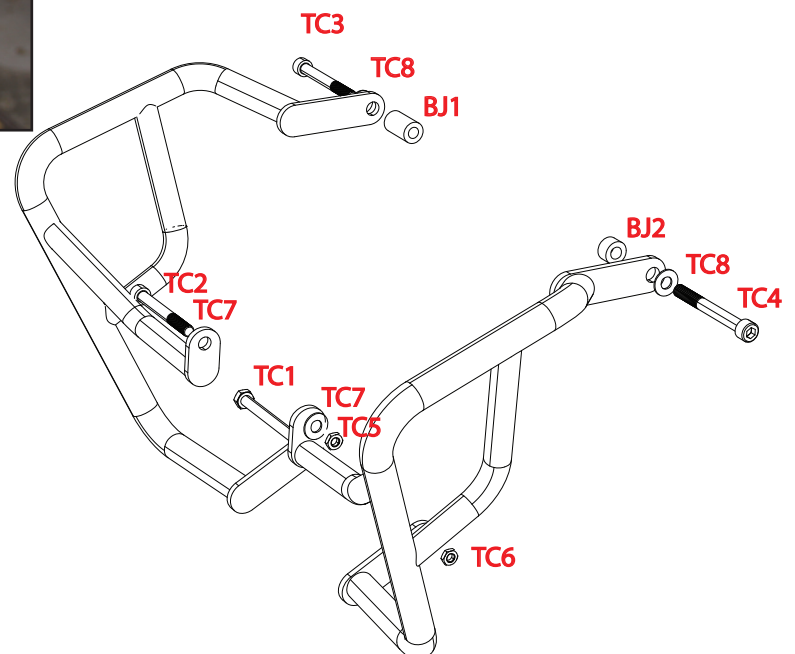

Al terminar la instalación de las partes, verifique que estén alineadas y que toda la tornillería esté debidamente apretada; reajuste todos los tornillos.



MASTECH

BMW G650 GS 11-UP

Assembly Instructions for Upper Crash Bars



Note:

Do not tighten the screws until they are completely aligned with the holes. Before the installation, please verify through the manual that all pieces and parts are complete.

Required Tools:

Hex Allen Wrench Set Socket set with ratchet
Combination Wrench Set



Kit Instalado

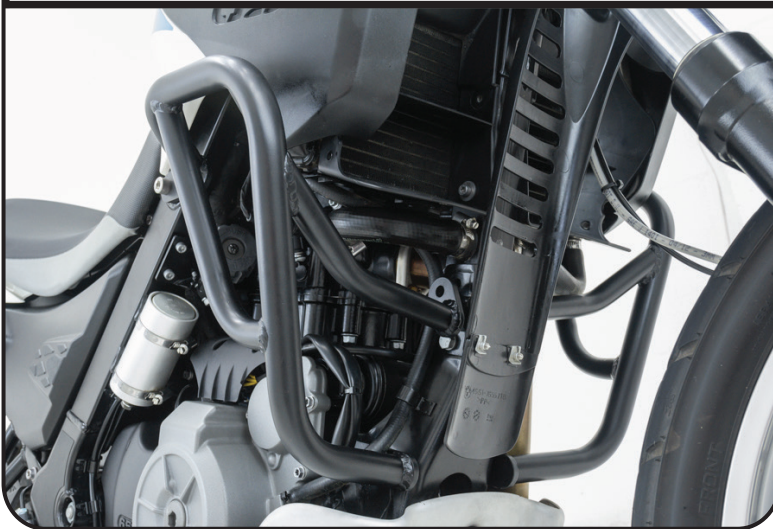

Instalación

Start by installing the right side crashbar.

1- Remove the marked bolt in *Image 1*, on both sides of the motorcycle.

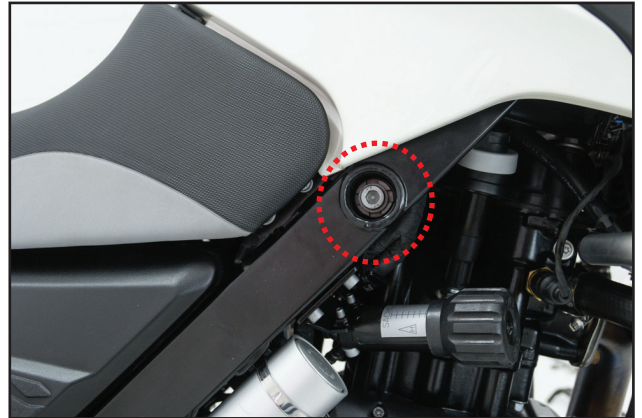
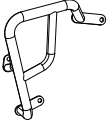
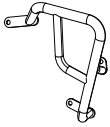
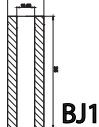



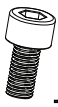







Image 1

El Kit Contiene:

Left Side Bar  Quantity: 1	Right Side Bar  Quantity: 1	Right Chassis Aluminum Bushing  BJ1 Quantity: 1	Left Chassis Aluminum Bushing  BJ2 Quantity: 1	Indented Hex Bolt M10 x 120 Galv.  TC1 Quantity: 1	Allen Bolt M8 X 75 galv  TC2 Quantity: 1
Allen Bolt M10 X 90 galv  TC3 Quantity: 1	Allen Bolt M10X 70 galv  TC4 Quantity: 1	Lock Nut M8 Galv.  TC5 Quantity: 1	Lock Nut M10 Galv.  TC6 Quantity: 1	Washers M8 galv.  TC7 Quantity: 2	Washers M10 galv.  TC8 Quantity: 2

2- Remove marked bolts in *Image 2*.

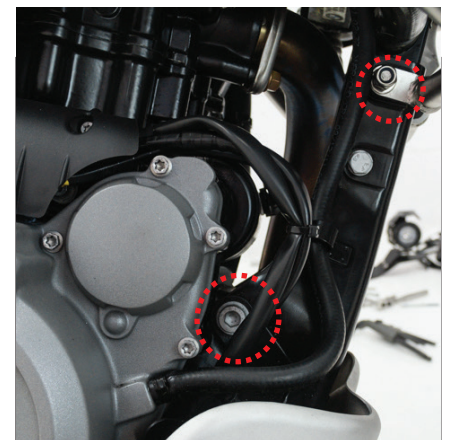

Image 2

3 - Install upper part of the Right Side Bar, with hardware BJ1, TC3 y TC8 as indicated in *Image 3* and the Diagram.

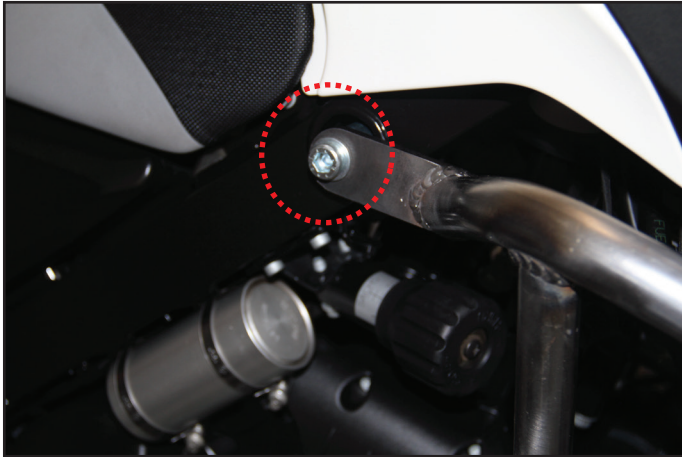

Image 3

4 - Install hardware TC2 y TC7 as indicated in *Image 4* and the Diagram.

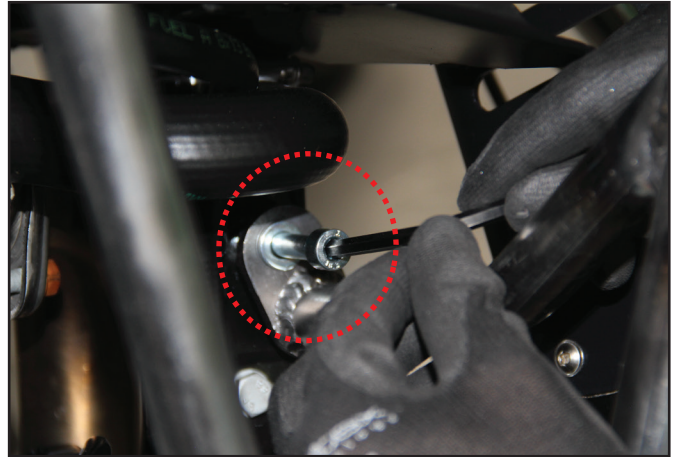

Image 4

5 - Install hardware TC1 as indicated in *Image 5* and the Diagram.

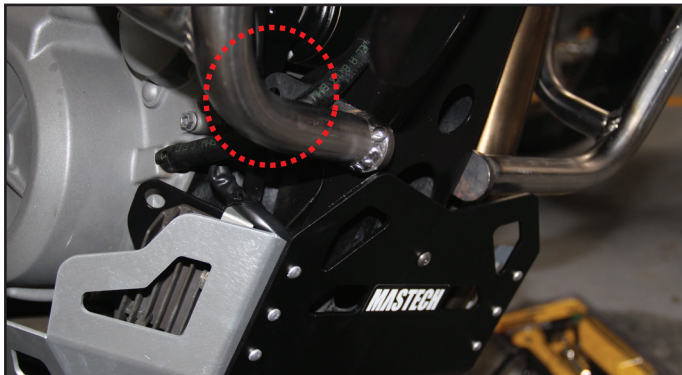
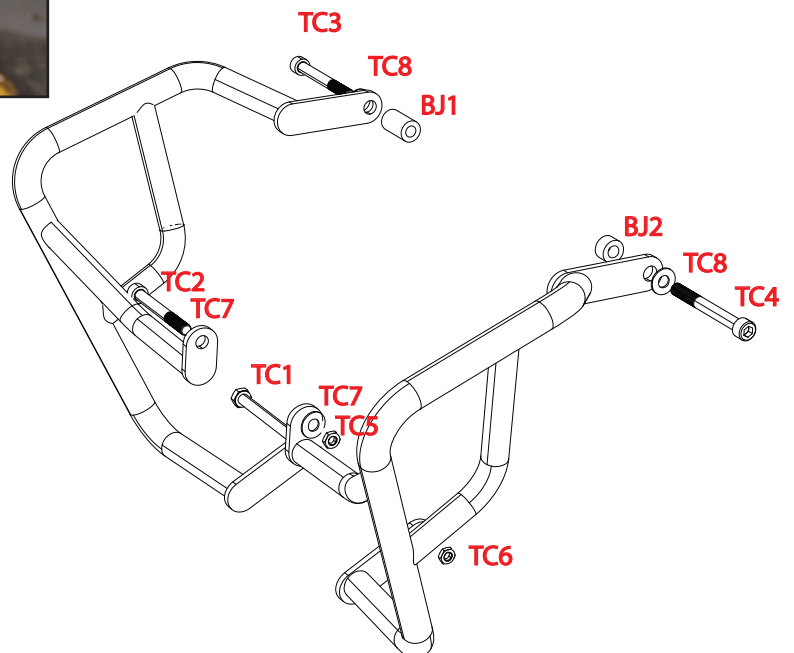

Image 5

6- To begin installing Left Side Bar start from step 3 using hardware BUJ2, TC4 Y TC8 as indicated in the Diagram.

7- When the Left Side Bar is completely assembled, secure bolts TC5 y TC6 with it's Lock Nuts as indicated in the Diagram below.



After completing installation, please check that every part is aligned and all the hardware is properly tightened